

Main Drive Components

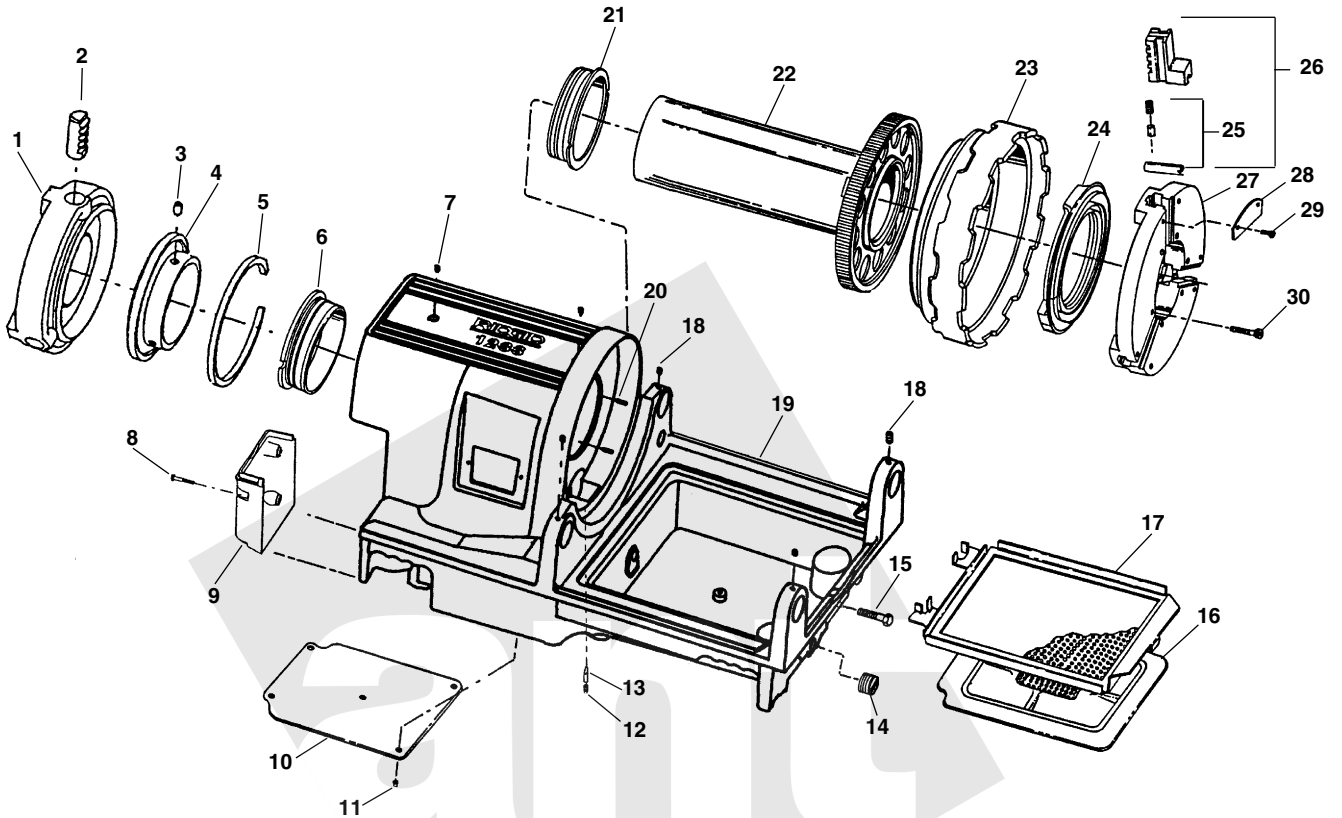

**NOTE: Order parts by Catalog Number only.
DO NOT order by Reference Number.**

Ref. No.	Catalog No.	Description	Ref. No.	Catalog No.	Description
1	61882	Rear Centering Head	17	54047	Chip Tray
2	61922	Centering Jaw Set	18	60025	5/16" - 18 Set Screw (4)
3	61247	Spiral Pins (3)	19	61887	Base (Incl. Ref. 9,10,11)
4	54002	Centering Scroll	20	45475	Bearing Retaining Pins (4)
5	61927	Retaining Ring	21	54017	Front Bearing
6	54017	Rear Bearing	22	54067	Spindle Assembly
7	54022	Oil Ball Valve (2)	23	54072	Hammer Wheel
8	92455	#10 - 24 x 3/4" Screw	24	54077	Chuck Scroll
9	61932	Motor Cover	25	54212	Jaw Insert Set
10	61937	Bottom Cover	—	54217	Jaw Insert f/Coated Pipe
11	87730	1/4" x 3/8" Screw (4)	—	59612	Jaw Insert f/SS Pipe
12	77905	5/16" x 1/4" Screw	26	54087	Chuck Jaw Set
13	54037	Motor Wedge	27	54082	Chuck Cap
14	54302	Drain Plug	28	54092	Chip Guard
15	54042	M-10 1.5 Hex Screw	29	58322	Screws 6 - 32 x 1/2" Pkg. of 6
16	54052	Oil Pan Liner	30	46775	1/4" x 1 3/4" Soc. Head Screw (6)

Carriage and Oil System

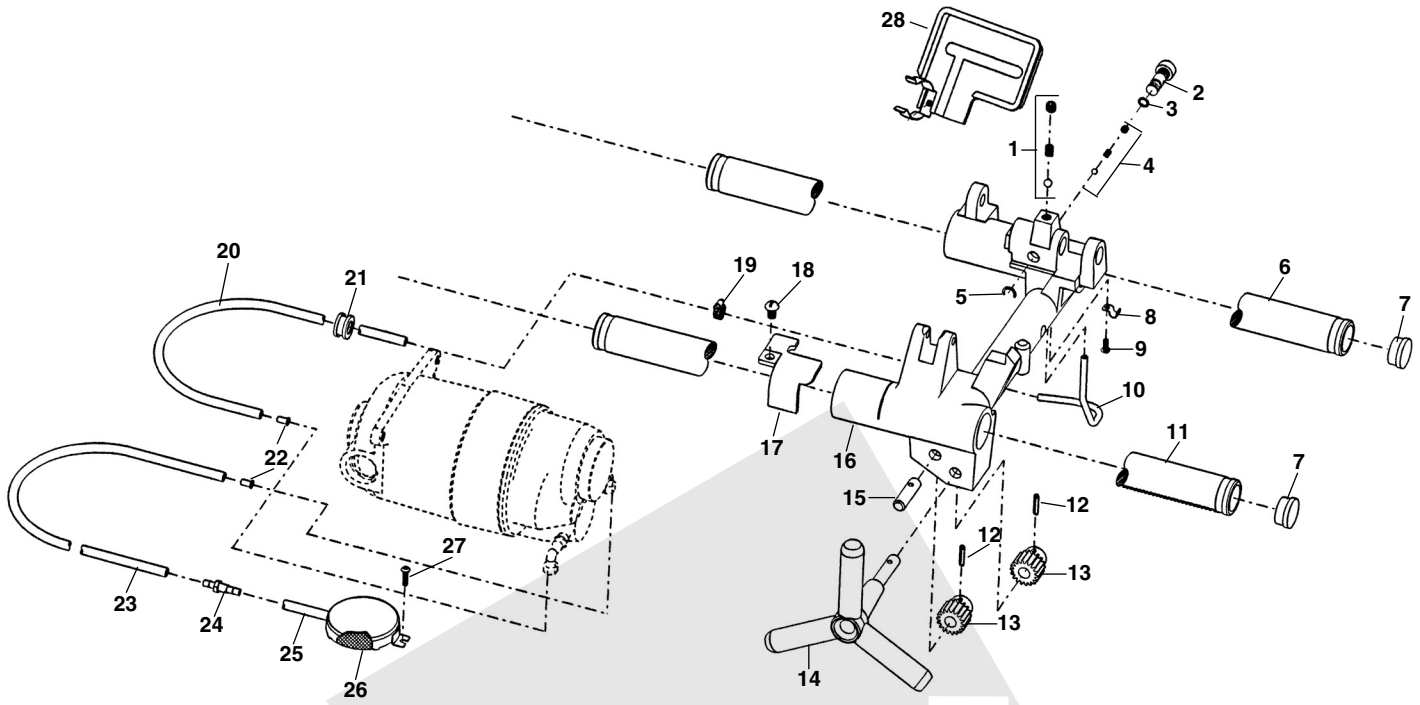

**NOTE: Order parts by Catalog Number only.
DO NOT order by Reference Number.**

Ref. No.	Catalog No.	Description
1	46810	Detente Assembly
2	54097	Spool Valve
3	54102	O-Ring
4	35307	Oil Pressure Relief Set
5	54107	Crescent Ring
6	54112	Rear Rail
7	35162	Rail Plug (4)
8	35062	Oil Line Clamp
9	79965	10-32 x 1/2" Screw
10	35067	Oil Tube
11	54117	Front Rail
12	34342	Roll Pin
13	57097	Pinion
14	35182	Hand Wheel
15	35187	Pinion Idler Shaft
	54122	Cap Plug (not shown)
16	54127	Carriage
17	54132	Carriage Stop
18	54137	5/16" - 18 x 1/2" Screw
19	35142	Hose Clamp
20	61282	Carriage Oil Line
21	47080	Oil Line Grommet
22	35117	Oil Line Insert
23	54152	Oil Intake Line
24	54142	Bulkhead Fitting
25	61897	Oil Filter Tube
26	58467	Filter Screen Assembly
27	45420	10-24 x 3/8" Screw
28	54517	Drip Pan

Motor

**3092
3192
3292
3192R
3292R**

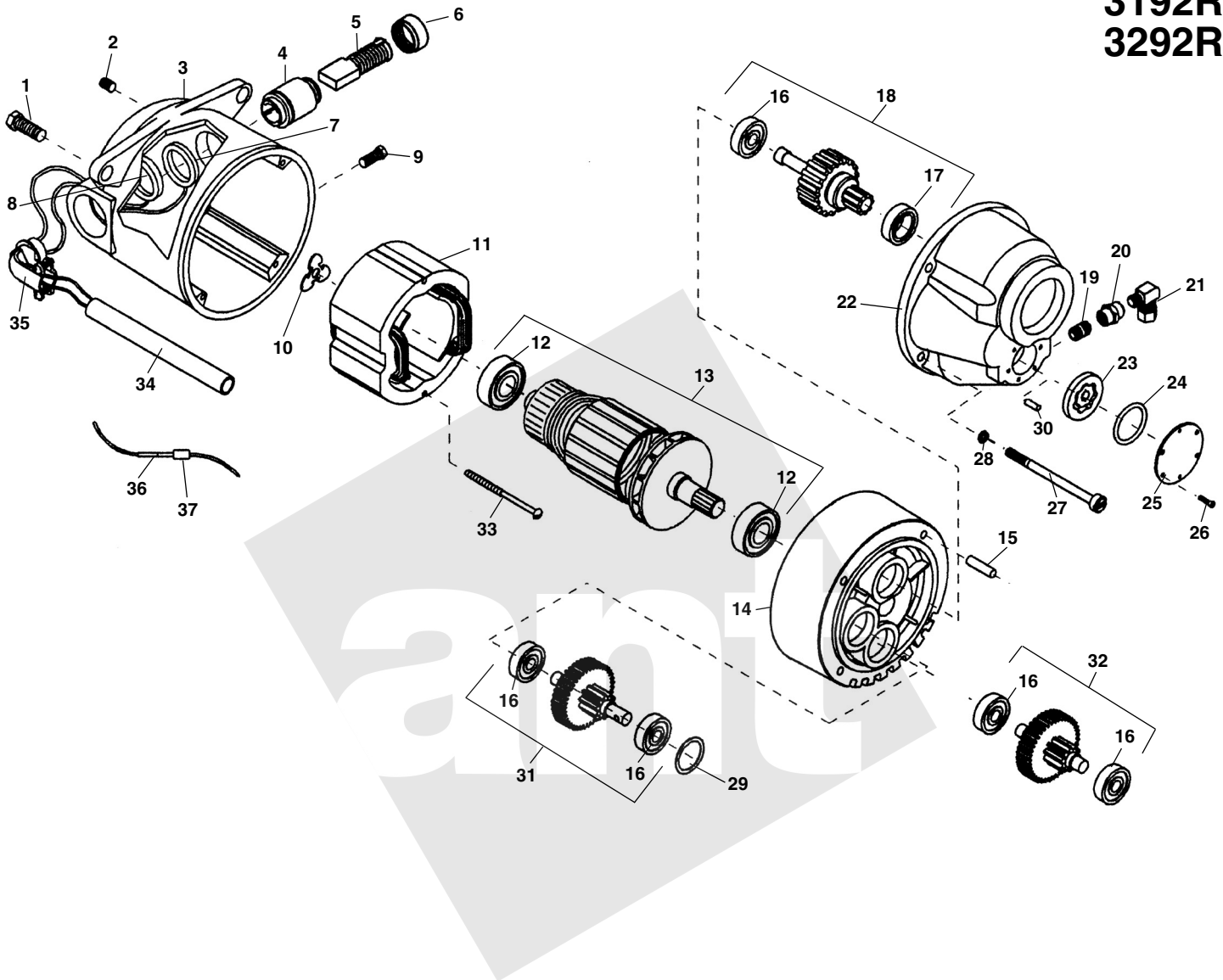

**NOTE: Order parts by Catalog Number only.
DO NOT order by Reference Number.**

Ref. No.	Catalog No.	Description	Ref. No.	Catalog No.	Description	Ref. No.	Catalog No.	Description
—	52457	Motor Model 3092, 100V	11	44015	Field 100/115V	23	96870	Gerotor Set
—	52462	Motor Model 3192, 115V	11	44035	Field 230V	24	96875	O-Ring
—	52467	Motor Model 3292, 230V	12	44565	Armature Bearing (2)	25	96840	Cover Plate
—	52472	Motor Model 3192R, 115V Rev.	13	52487	100V Armature	26	96890	Screw #4 x 3/8" (6)
—	52477	Motor Model 3292R, 230V Rev.	13	52497	115V Armature	27	45075	Screw 1/4" - 20
1	85915	Motor Mounting Bolt (2)	13	52492	230V Armature	28	45150	Lockwasher 1/4"
2	39770	Set Screw 1/4" - 20 x 1/4" (2)	14	54552	Fan Housing Assembly	29	96880	Oil Seal
3	52482	Motor Housing	15	45165	Dowel Pin	30	96885	Pin
4	45025	Brush Holder Set (2)	16	44760	Gear Bearing	31	52522	1st Gear Assembly
5	44540	Brush Assembly Set (2)	17	45315	Front Bearing	32	52527	2nd Gear Assembly
6	44545	Brush Cap Set (2)	18	45370	Main Drive Gear Assembly	33	44555	Screw 10-24 x 3"
7	86685	Red Brush Lead	19	52507	1/8" NPT Close Nipple (2)	34	63382	Plastic Tube
8	86680	White Brush Lead	20	52512	1/8" Coupling (2)	35	46900	90 Connector
9	83500	Field Locking Screw	21	52517	Elbow Compression Fitting (2)	36	16946	Male Wire Connector
10	44580	Loading Spring	22	96830	Gear Case	37	16956	Female Wire Connector

Electrical Components
Push Button Type Switch

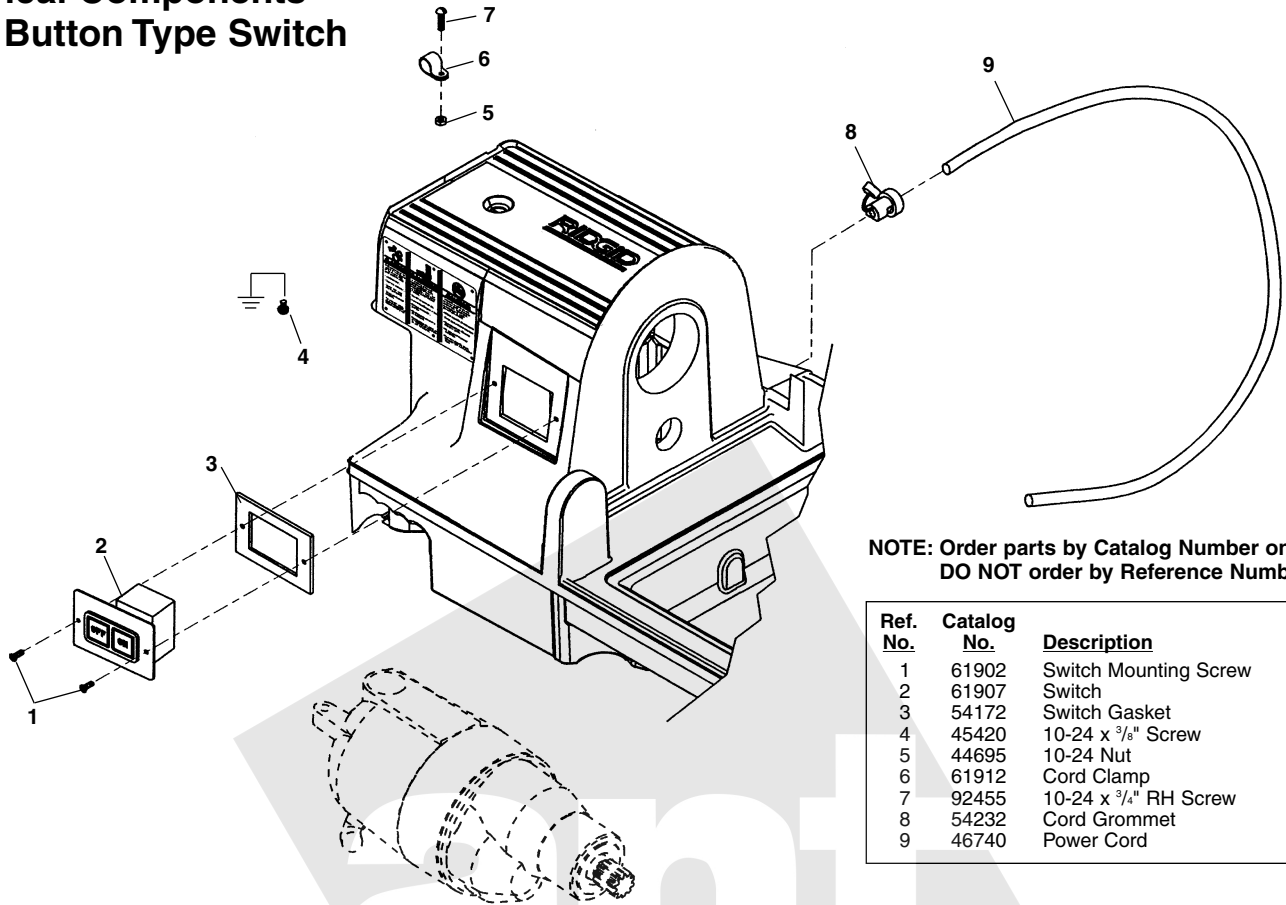

**NOTE: Order parts by Catalog Number only.
DO NOT order by Reference Number.**

Ref. No.	Catalog No.	Description
1	61902	Switch Mounting Screw
2	61907	Switch
3	54172	Switch Gasket
4	45420	10-24 x 3/8" Screw
5	44695	10-24 Nut
6	61912	Cord Clamp
7	92455	10-24 x 3/4" RH Screw
8	54232	Cord Grommet
9	46740	Power Cord

Lever Type Switch

Ref. No.	Catalog No.	Description
1	61397	Switch Knob
2	54167	Switch Face Plate
3	54157	Switch & Screws
4	61902	Slotted Pan Head Screw #6 - 32 x 1/2"
5	61917	Switch Plate
6	54172	Switch Gasket
7	63387	Brown Wire
8	63392	Blue Wire
9	63372	Suppressor
—	63387	Brown Lead Wire
—	63392	Blue Lead Wire
10	45420	10-24 x 3/8" Screw
11	44695	10-24 Nut
12	61912	Cord Clamp
13	92455	10-24 x 3/4" RH Screw
14	36652	Foot Switch (B-296)
	40022	Foot Switch f/Aust. (B-299)
	40017	Foot Switch f/U.K. (B-298)
15	54177	Strain Relief w/Locknut
16	63377	Ferrite Bead
17	43552	Cable Tie

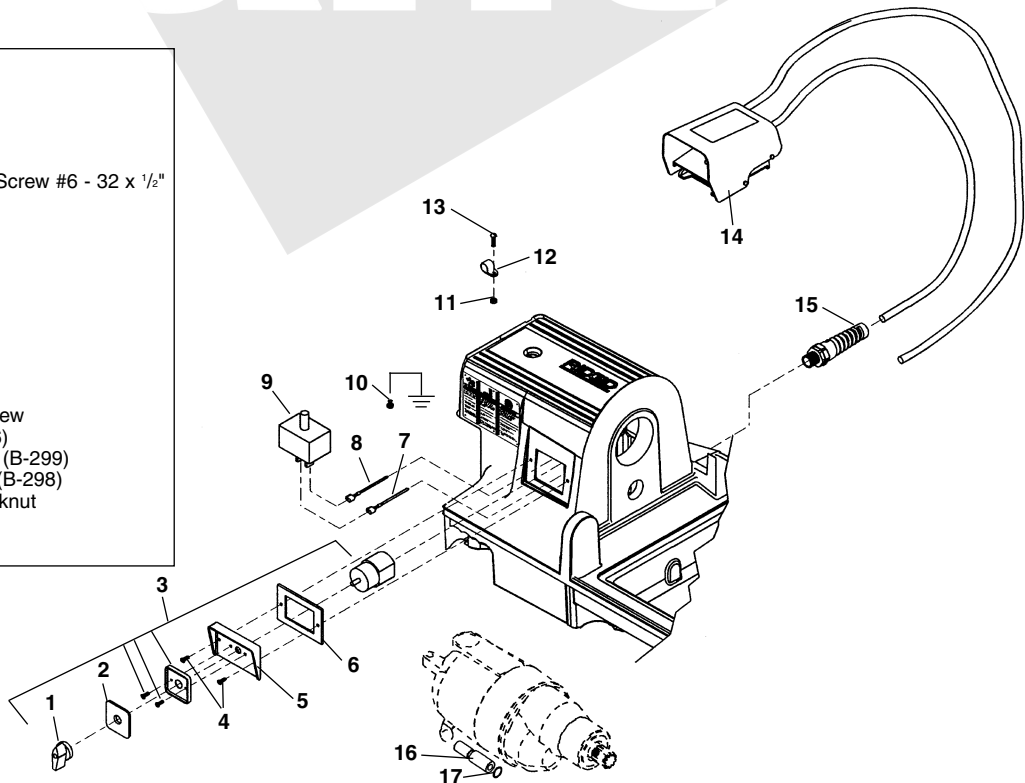

No. 763 Pipe Cutter

**NOTE: Order parts by Catalog Number only.
DO NOT order by Reference Number.**

Ref. No.	Catalog No.	Description
—	52452	763 Cutter Complete
1	54197	Feed Screw Handle
2	61872	Cutter Frame
3	58090	1/4" x 1" Roll Pin
4	61877	Bracket
5	54300	Roll Pin
6	44185	E1032 Cutter Wheel
7	34780	Pin & Clip
8	52247	Wheel Housing
9	46960	Rolls f/Steel Pipe (2)
—	43682	Rolls f/Coated Pipe (2)
10	46662	Roll Pin (2)
11	45520	Hinge Pin

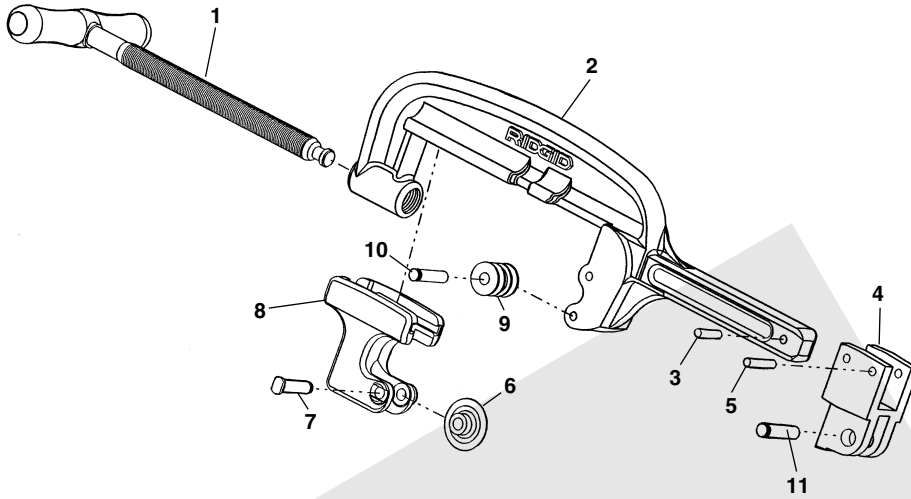

No. 743 Reamer

Ref. No.	Catalog No.	Description
—	52272	743 Reamer Complete
1	36262	Shoulder Screw
2	36267	Pivot Pin
3	36272	Reamer Arm
4	52277	Reamer Cone
5	35355	Split Roll Pin

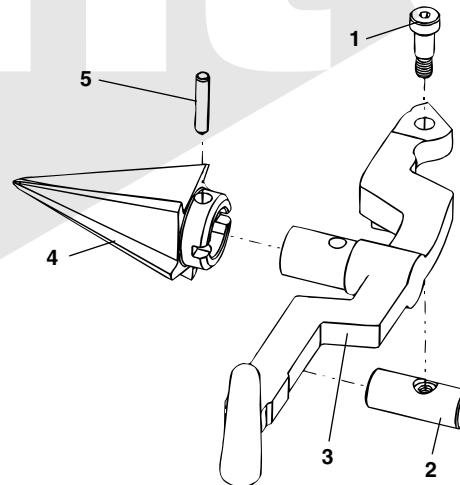

No. 724 NPT & 924 BSPT 1/2" - 3/4" Die Heads
No. 726 NPT & 926 BSPT 1" - 2" Die Heads

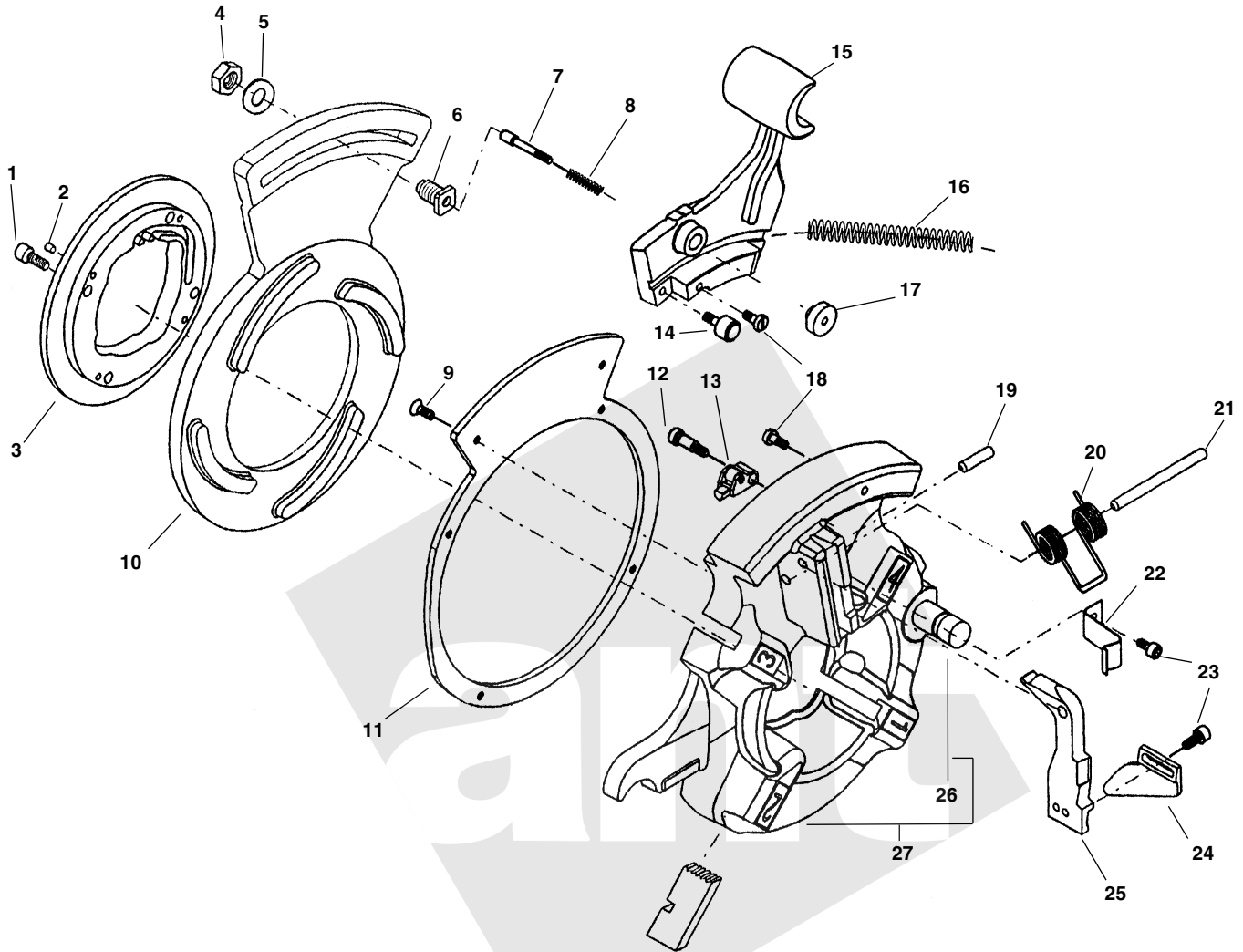

**NOTE: Order parts by Catalog Number only.
 DO NOT order by Reference Number.**

Ref. No.	Catalog No.	Description	Ref. No.	Catalog No.	Description
—	50317	924 1/2" - 3/4" BSPT Die Head	11	52442	Support Ring
—	50322	926 1" - 2" BSPT Die Head	12	34877	Soc. Hd. Shoulder Bolt 1/4" x 1/2"
—	54447	724 1/2" - 3/4" NPT Die Head	13	61617	Rocker Release Assembly
—	54442	726 1" - 2" NPT Die Head	14	52377	Slide Roller Bearing (2)
1	32205	Screw 1/4" - 20 x 5/8" SHCS (4)	15	58667	Adjuster Slide
2	60097	Detente Plunger (4)	16	61612	Release Spring
3	52292	Retaining Ring 1/2" - 3/4", 1" - 2"	17	61597	Adjuster Knob
4	61587	Jam Nut 3/8"	18	52372	Spring Retainer (2)
5	61592	Flat Washer 3/8"	19	87940	Roll Pin 1/4" x 7/8"
6	61607	Adjuster Bolt	20	52387	Trigger Spring
7	61602	Adjuster Plunger	21	52397	Spring Mounting Pin
8	52342	Adjuster Spring	22	60092	Trigger Spring
9	52447	Screw #10-24 x 1/2" FHCS (6)	23	45750	Screw #10-24 x 3/8" SHCS (2)
10	52312	Cam Plate BSPT 924, 1/2" - 3/4"	24	52417	Adjustable Trigger
	52317	Cam Plate BSPT 926, 1" - 2"	25	52422	Trigger Pivot
	56067	Cam Plate NPT 724, 1/2" - 3/4"	26	59832	Die Head Post
	56072	Cam Plate NPT 726, 1" - 2"	27	52432	Die Head w/Post

No. 728 NPT & 928 BSPT 2 1/2" - 3" Die Heads

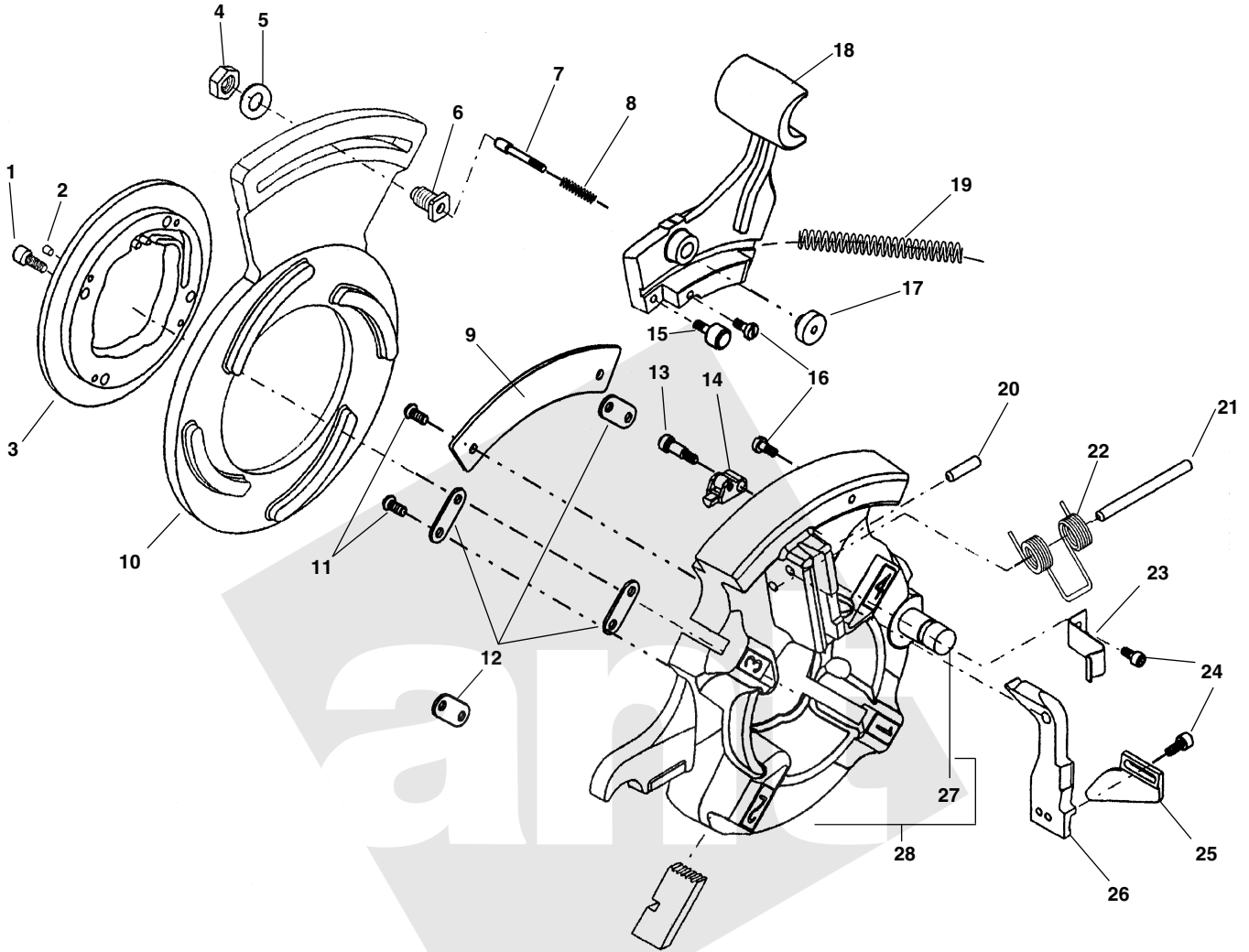

**NOTE: Order parts by Catalog Number only.
DO NOT order by Reference Number.**

Ref. No.	Catalog No.	Description	Ref. No.	Catalog No.	Description
—	54437	728 2 1/2" - 3" NPT Die Head	13	34877	Soc. Hd. Shoulder Bolt 1/4" x 1/2"
—	50327	928 2 1/2" - 3" BSPT Die Head	14	61617	Rocker Release Assembly
—	59522	928 2 1/2" - 3" BSPT Die Head - Taiwan	15	52377	Slide Roller Bearing (2)
1	32205	Screw 1/4" - 20 x 5/8" SHCS (4)	16	52372	Spring Retainer (2)
2	60097	Detente Plunger (4)	17	61597	Adjuster Knob
3	52287	Retaining Ring	18	58667	Adjuster Slide
4	61587	Jam Nut 3/8" - 16 (2)	19	61612	Release Spring
5	61592	Flat Washer 3/8"	20	87940	Roll Pin 1/4" x 7/8"
6	61607	Adjuster Bolt	21	52397	Spring Mounting Pin
	59527	Adjuster Bolt - Taiwan	22	52387	Trigger Spring
7	61602	Adjuster Plunger	23	60092	Trigger Spring
8	52342	Adjuster Spring	24	45750	Screw #10-24 x 3/8" SHCS (2)
9	75802	Rocker Cover	25	52412	Adjustable Trigger
10	56077	Cam Plate NPT - 728 Die head	26	52422	Trigger Pivot
	52307	Cam Plate BSPT - 928 Die head	27	59832	Die Head Post
11	39542	Screw #10-24 x 1/2" BHCS (10)	28	72272	Die Head w/Post
12	75797	Retaining Plate (4)			

Wiring Diagram

100V-115V-230V, 26-60 Hz

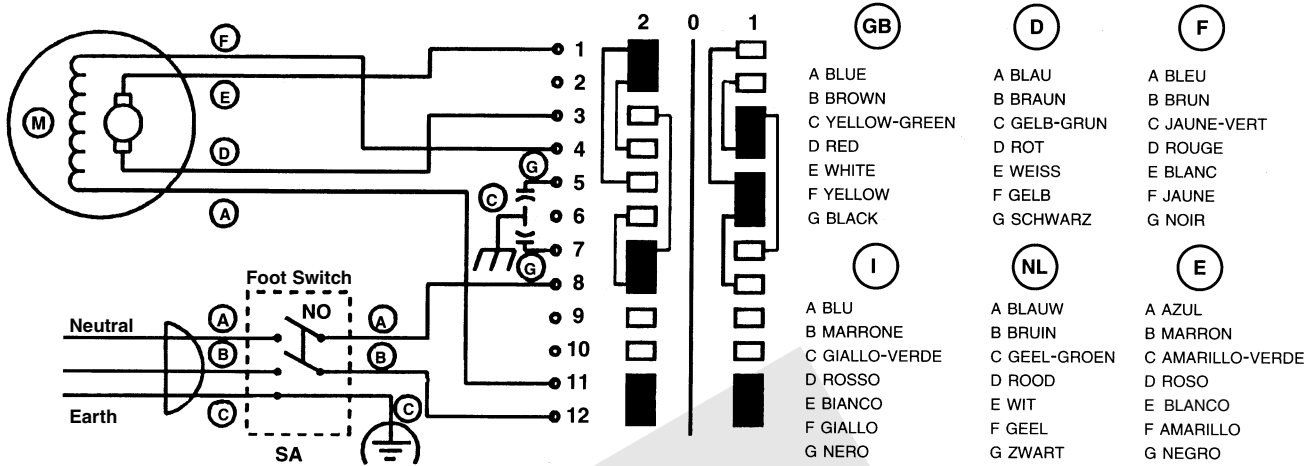

Wiring Diagram 115V (European Model)

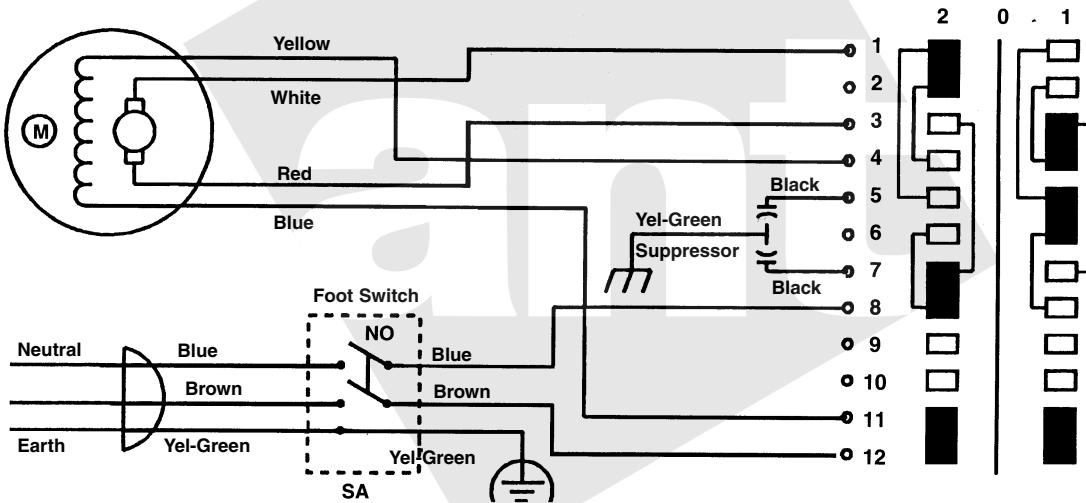

Wiring Diagram 230V (European Model)

